

DELIVERISTA STREET HUB

CITY HALL PARK



REST

RECHARGE

REPAIR

DESIGNATED LANDMARK + HISTORIC DISTRICT

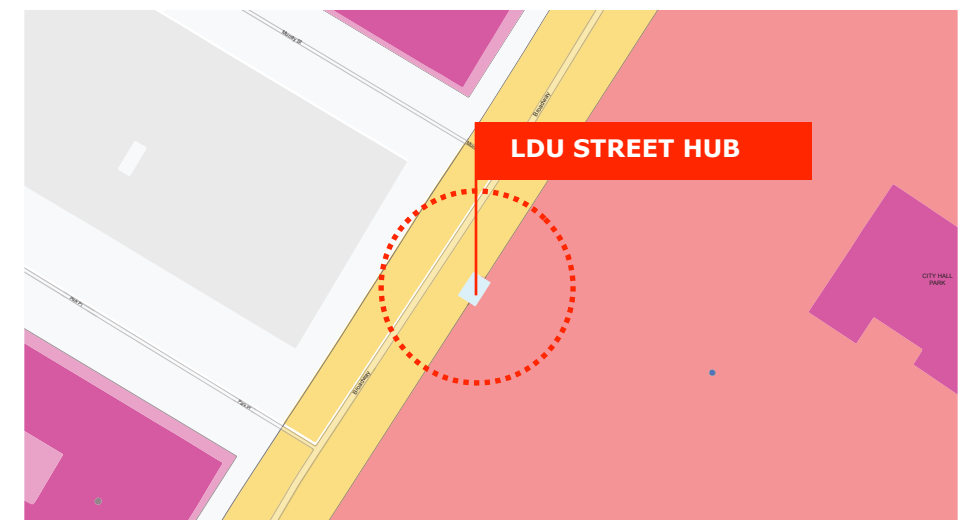
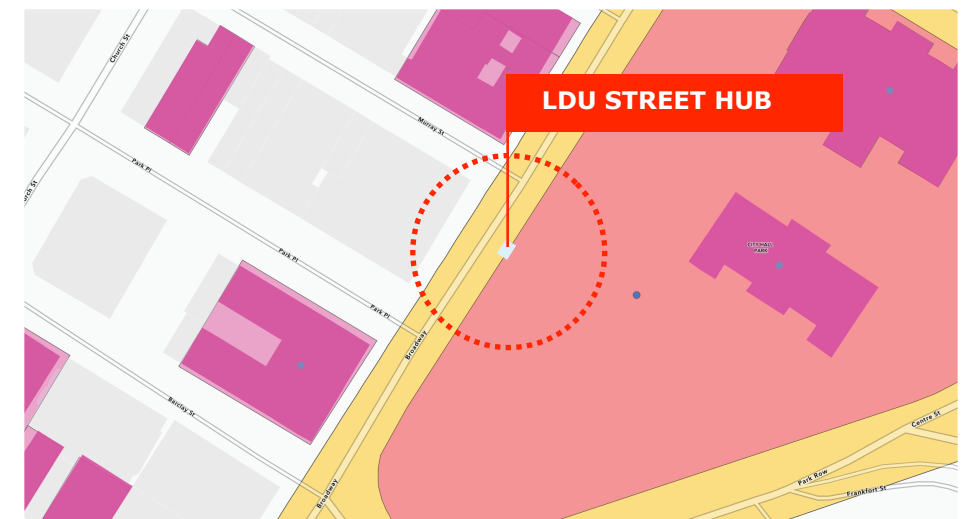
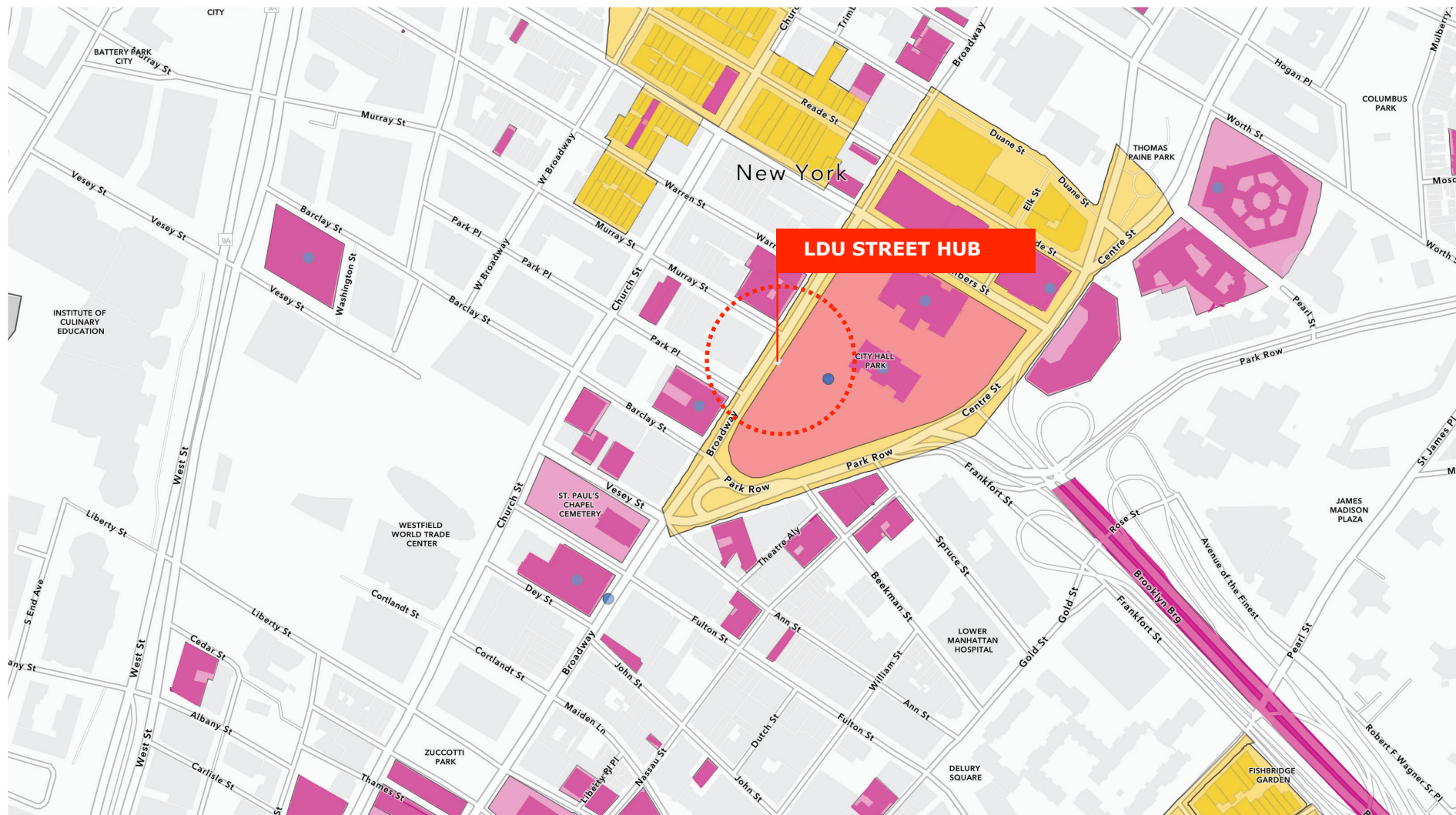

REST

RECHARGE

REPAIR

EXISTING CONDITIONS

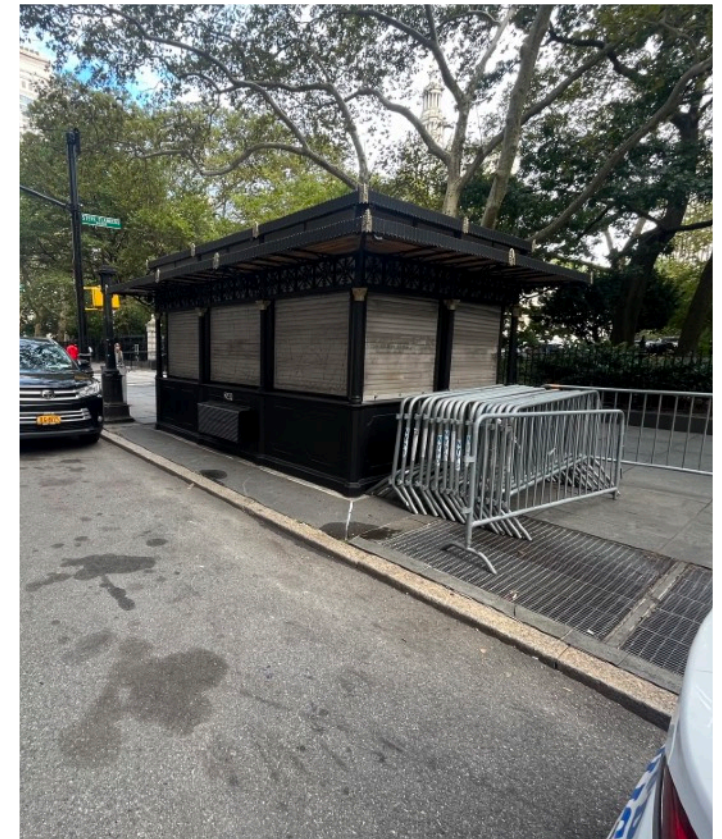

REST

RECHARGE

REPAIR

VOLUMETRIC COMPARISON

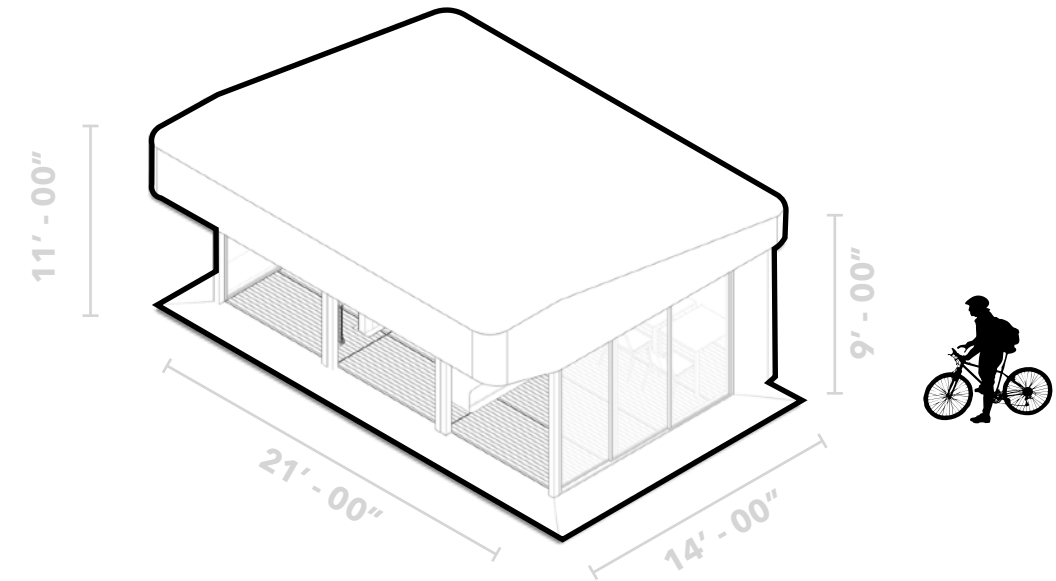
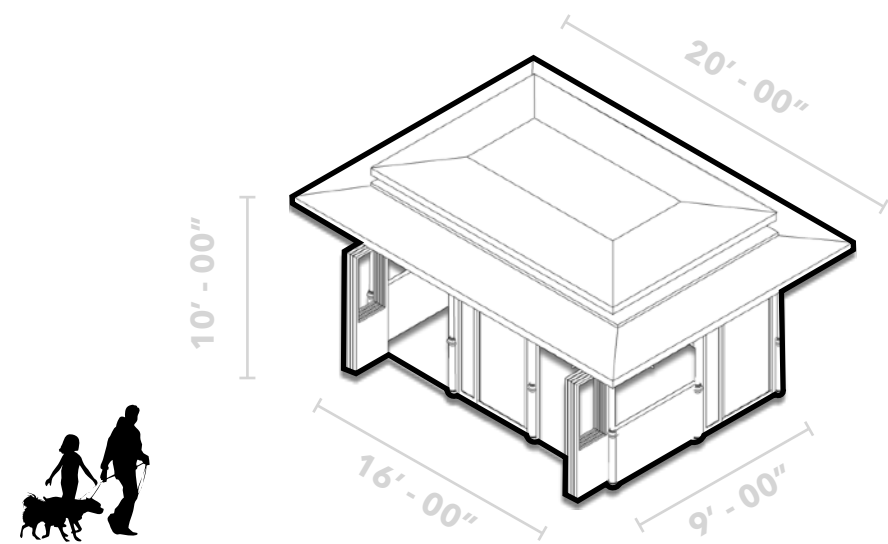

EXISTING

PROPOSED

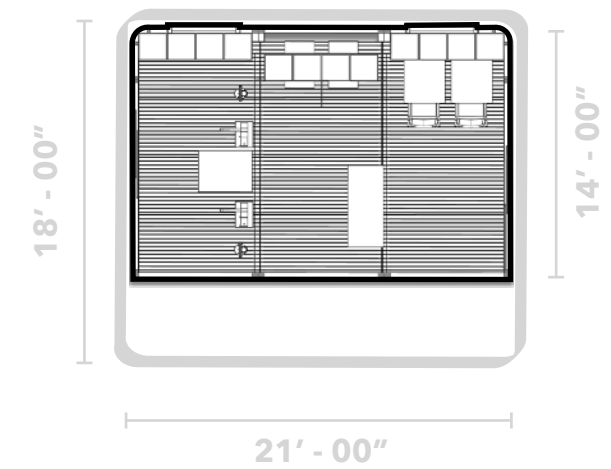
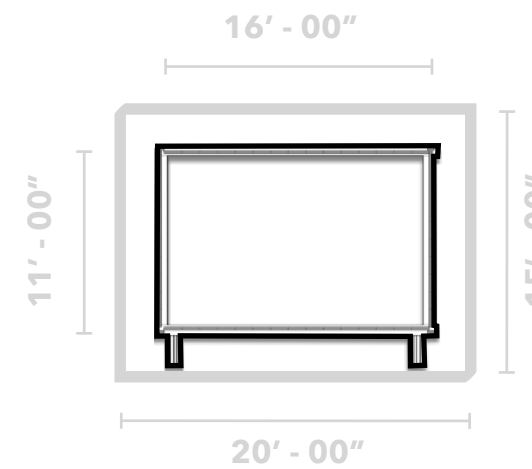
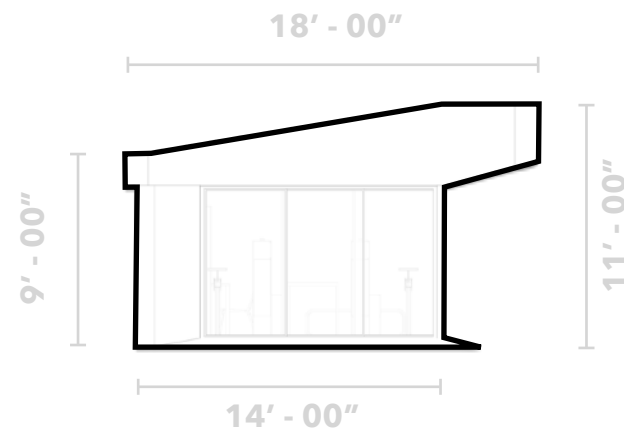
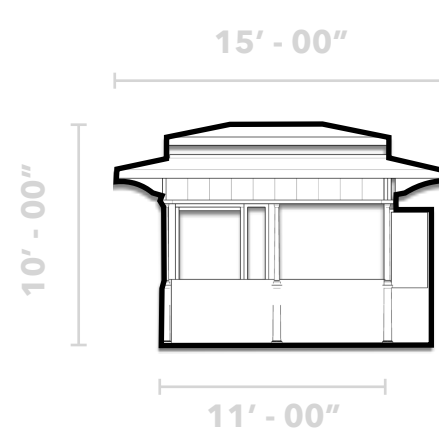

EXISTING

PROPOSED

EXISTING

PROPOSED

FOOTPRINT COMPARISON

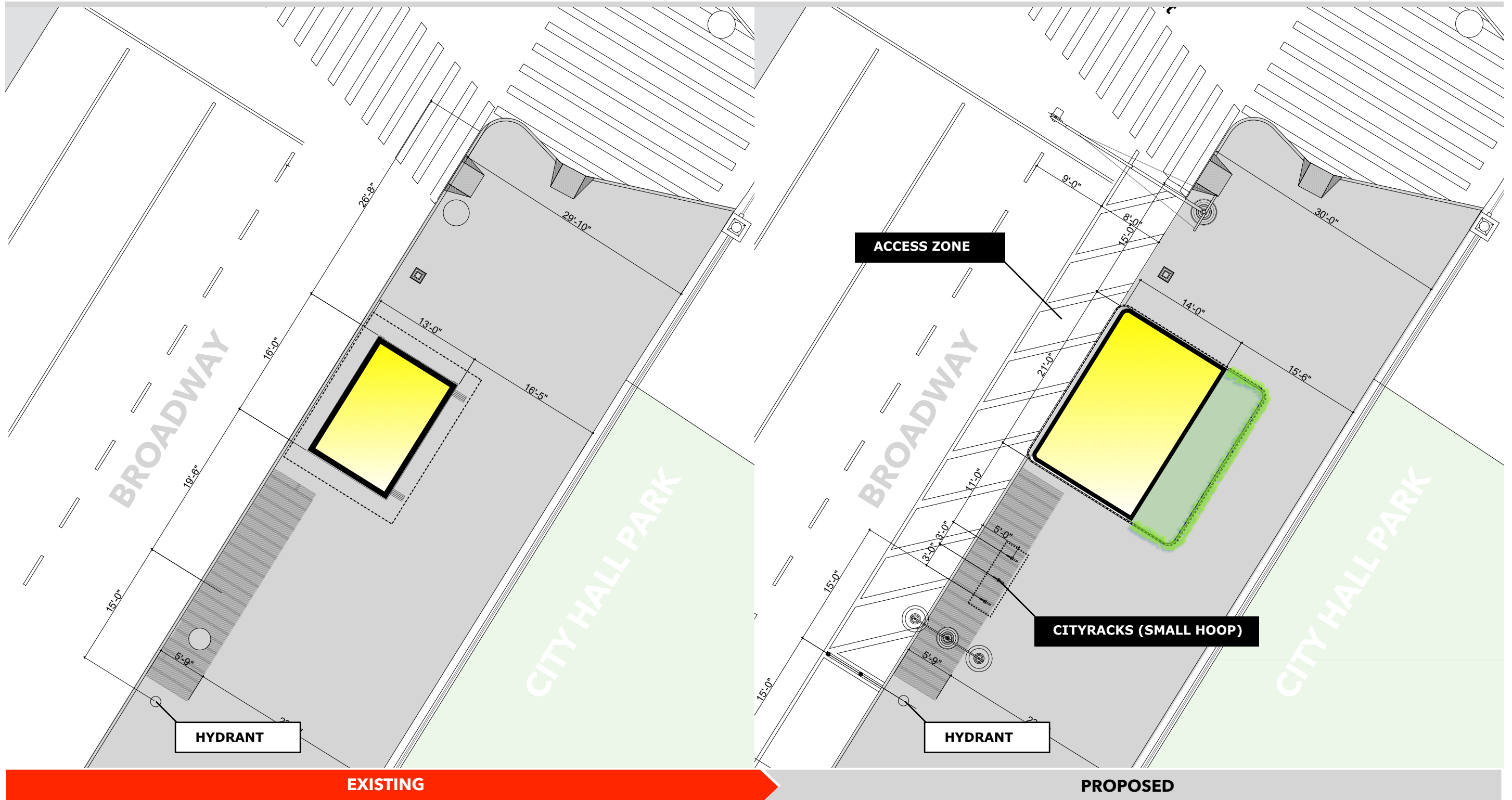

SITE PLAN

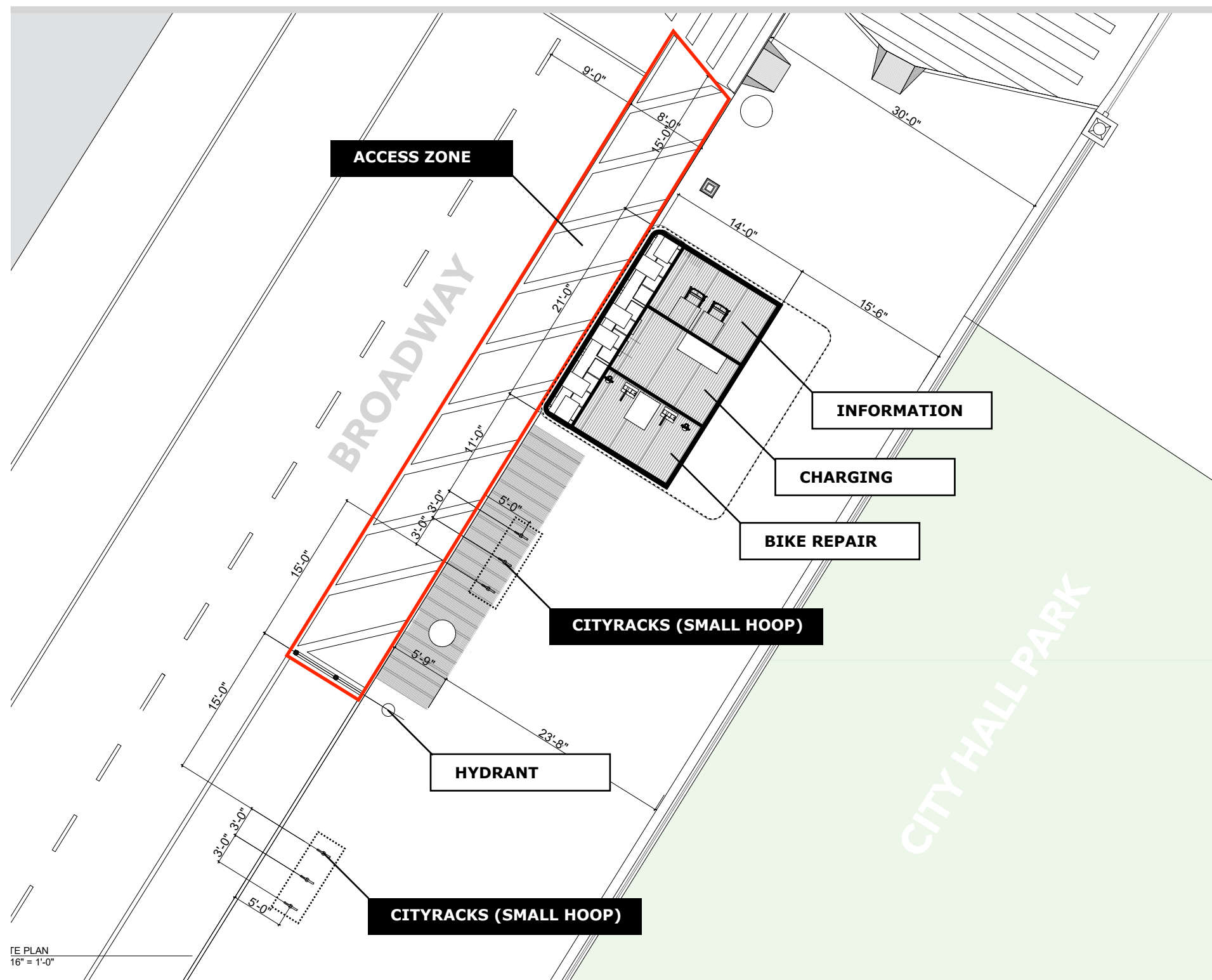

TE PLAN
16" = 1'-0"



CITYRACK (SMALL HOOP)



EXISTING CITYRACK ON SITE

VOLUMETRIC ANALYSIS

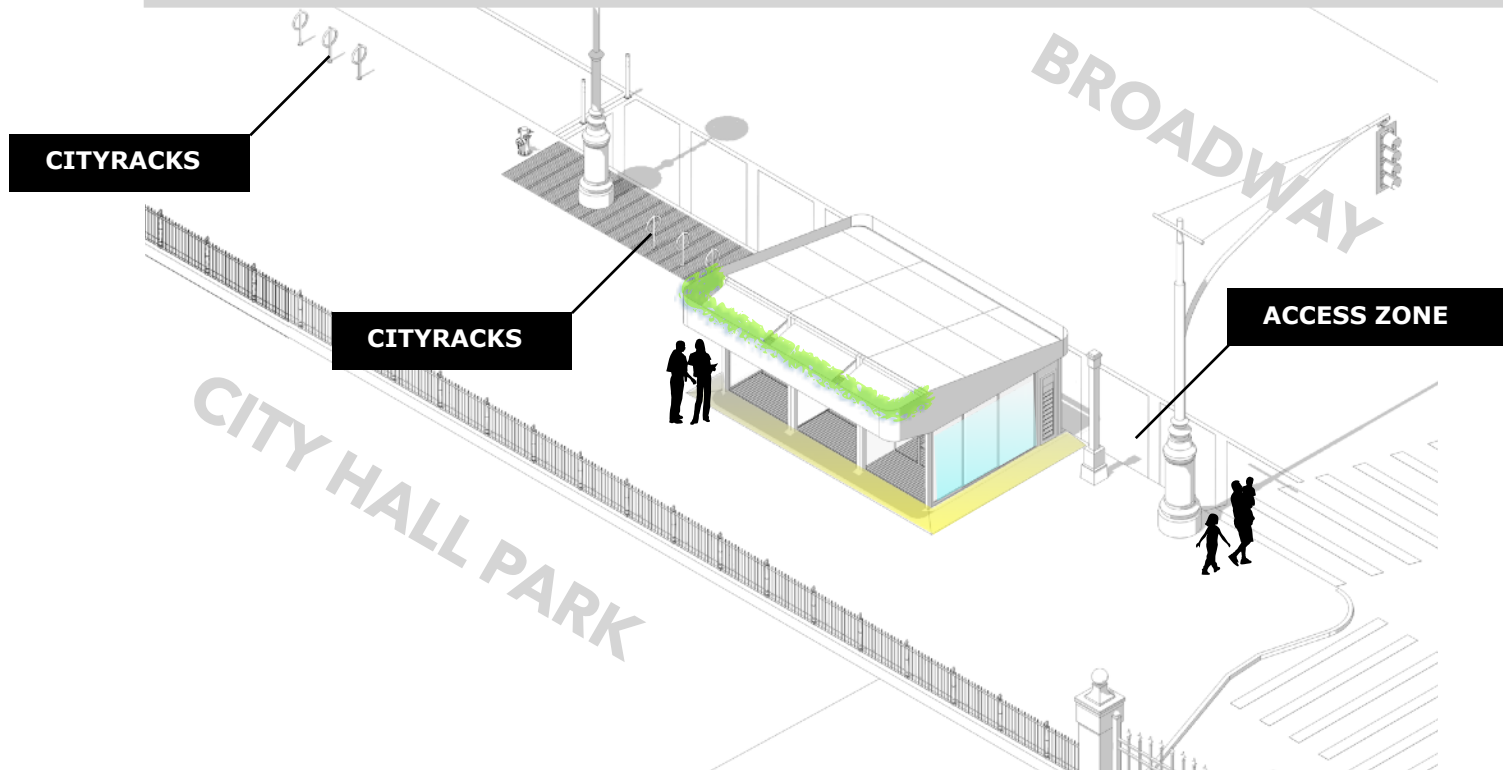

SOUTH WEST FACADE

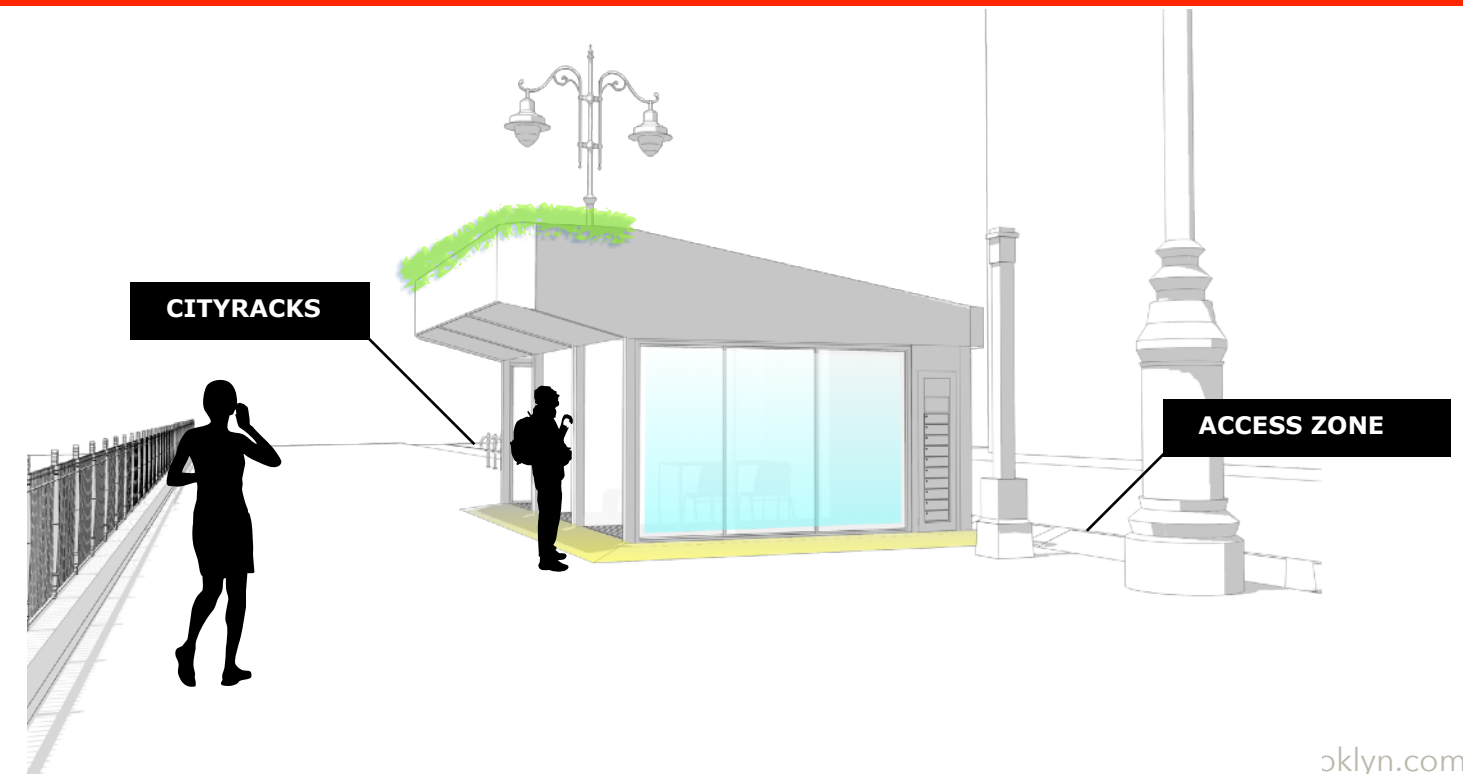

VIEW FROM MURRAY ST



#socialfurniture

oklyn.com

VOLUMETRIC ANALYSIS

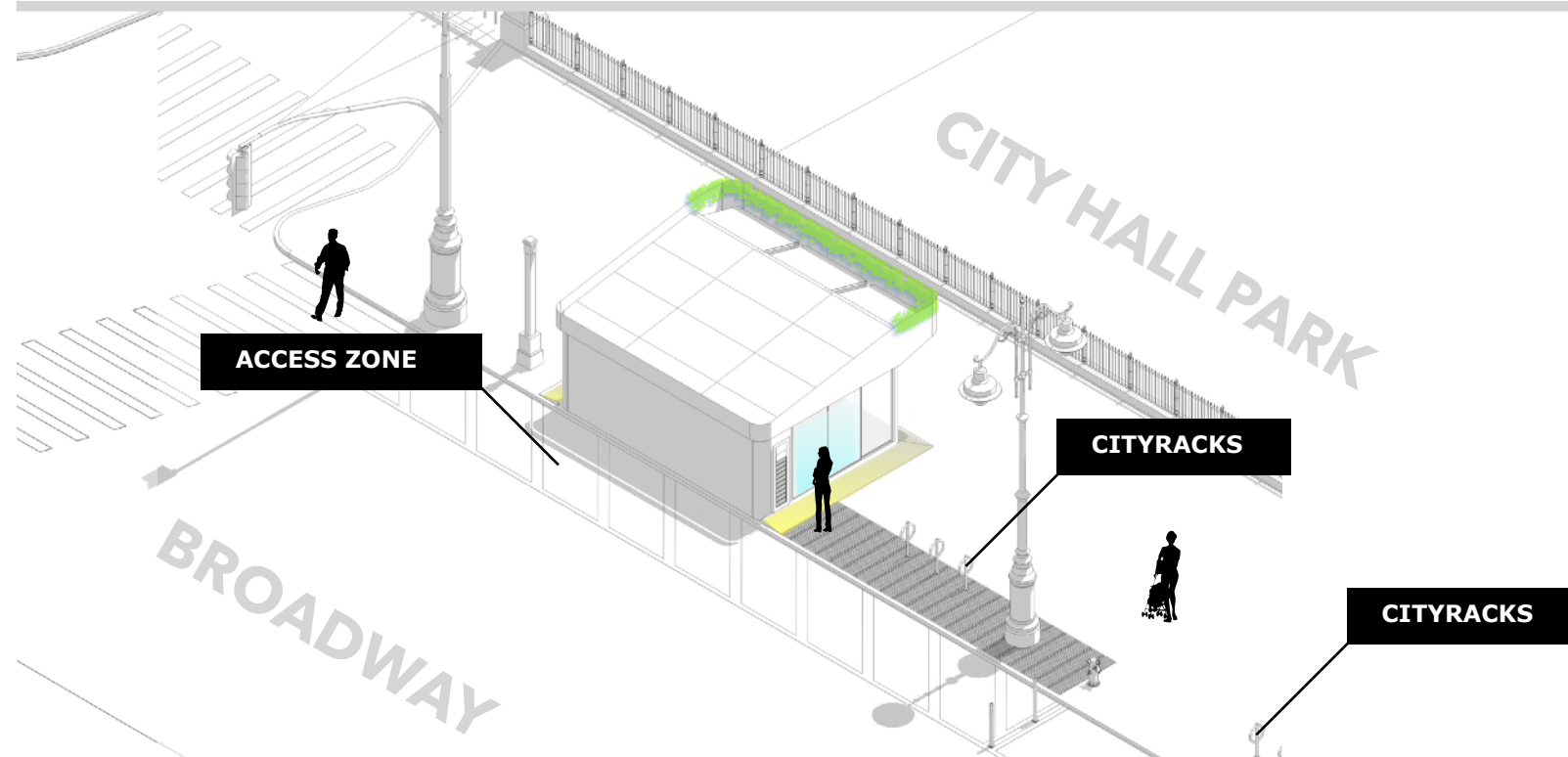

NORTH EAST FACADE

VIEW FROM PARK PL

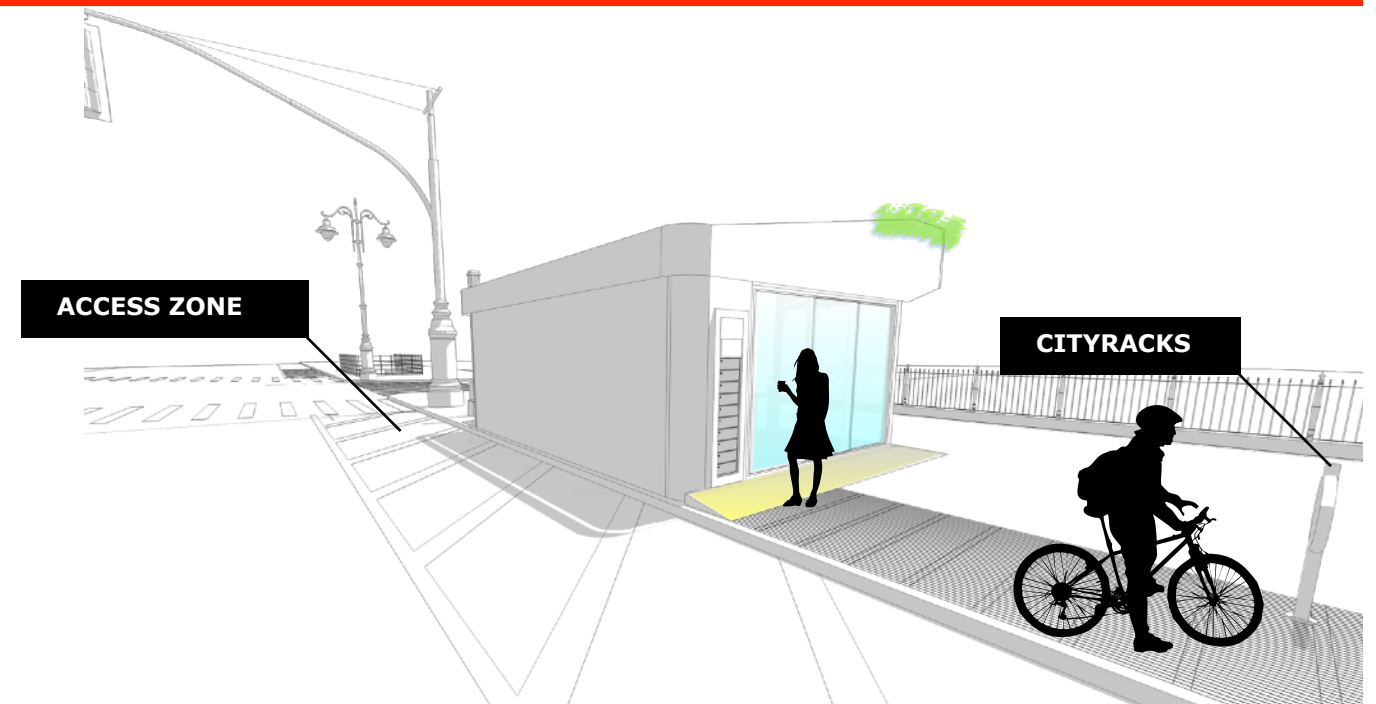

MATERIALS + FINISHES ANALYSIS



EXISTING



PROPOSED

MATERIALS + FINISHES ANALYSIS

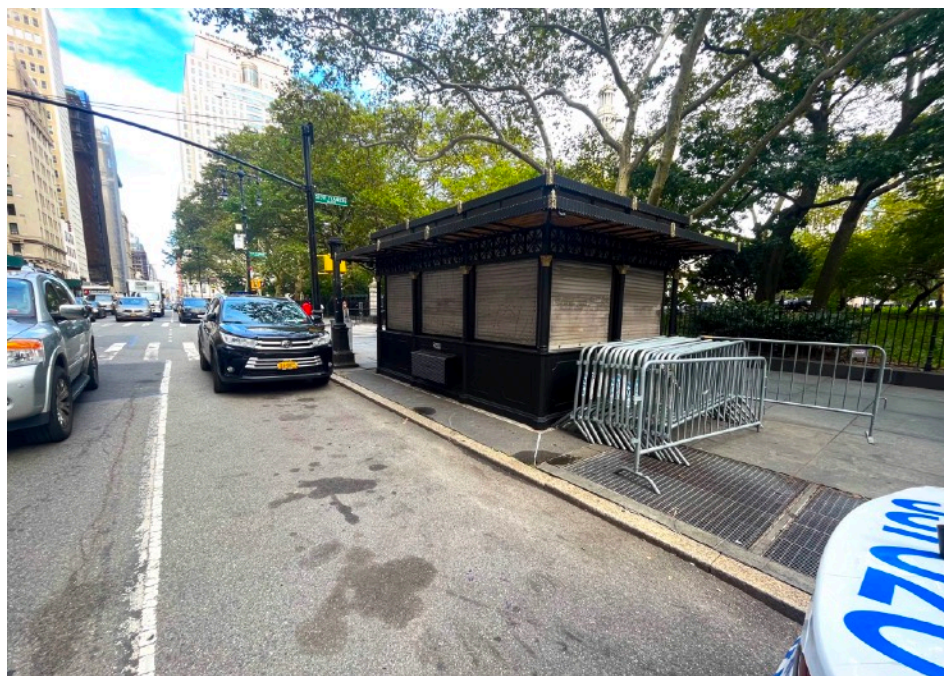

EXISTING



PROPOSED

MATERIALS + FINISHES

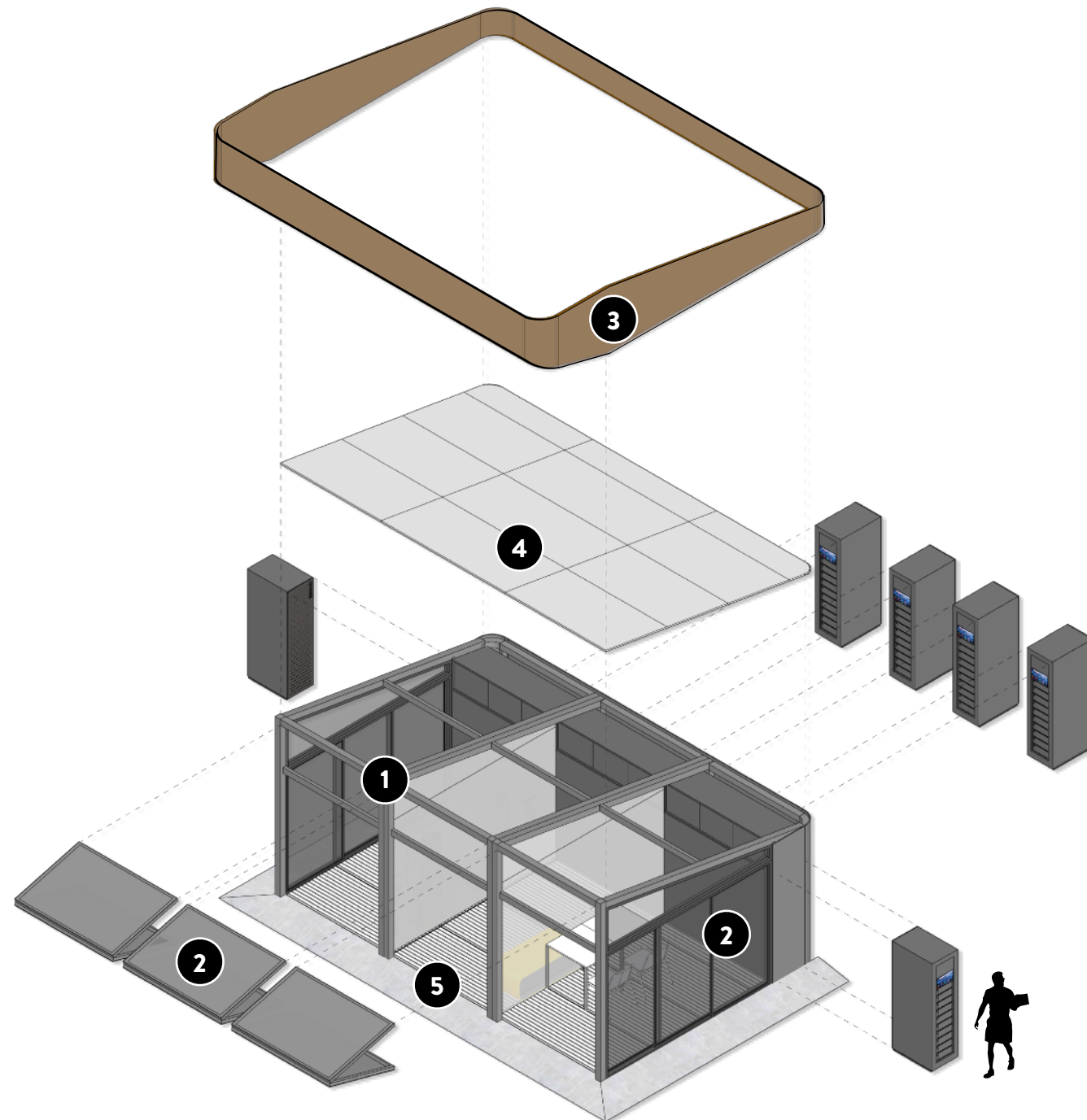

- 1 Powder Coated Aluminum Frame
- 2 Tempered Glass + Anti-graffiti Film
- 3 Powder Coated Perforated Aluminum Panels
- 4 Powder Coated Insulated Aluminum Panels
- 5 Fiberglass Grating w Aluminum Substructure

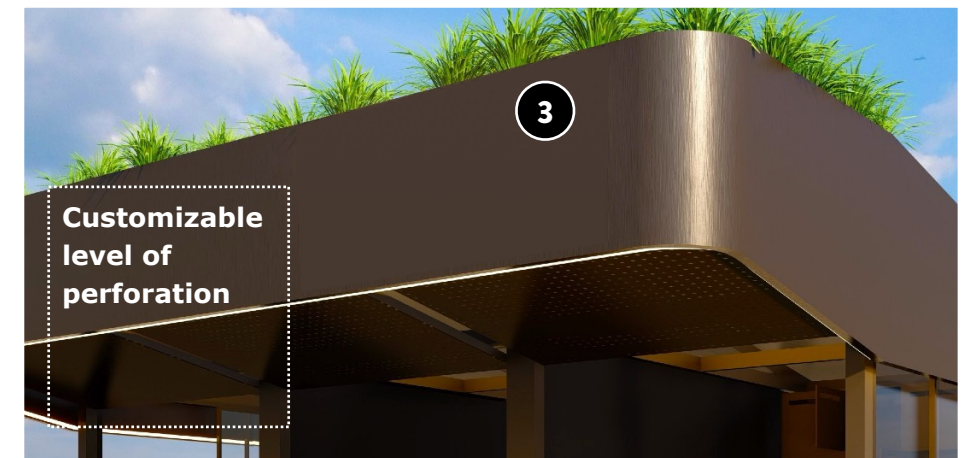

REST

RECHARGE

REPAIR

SYSTEMS + FEATURES

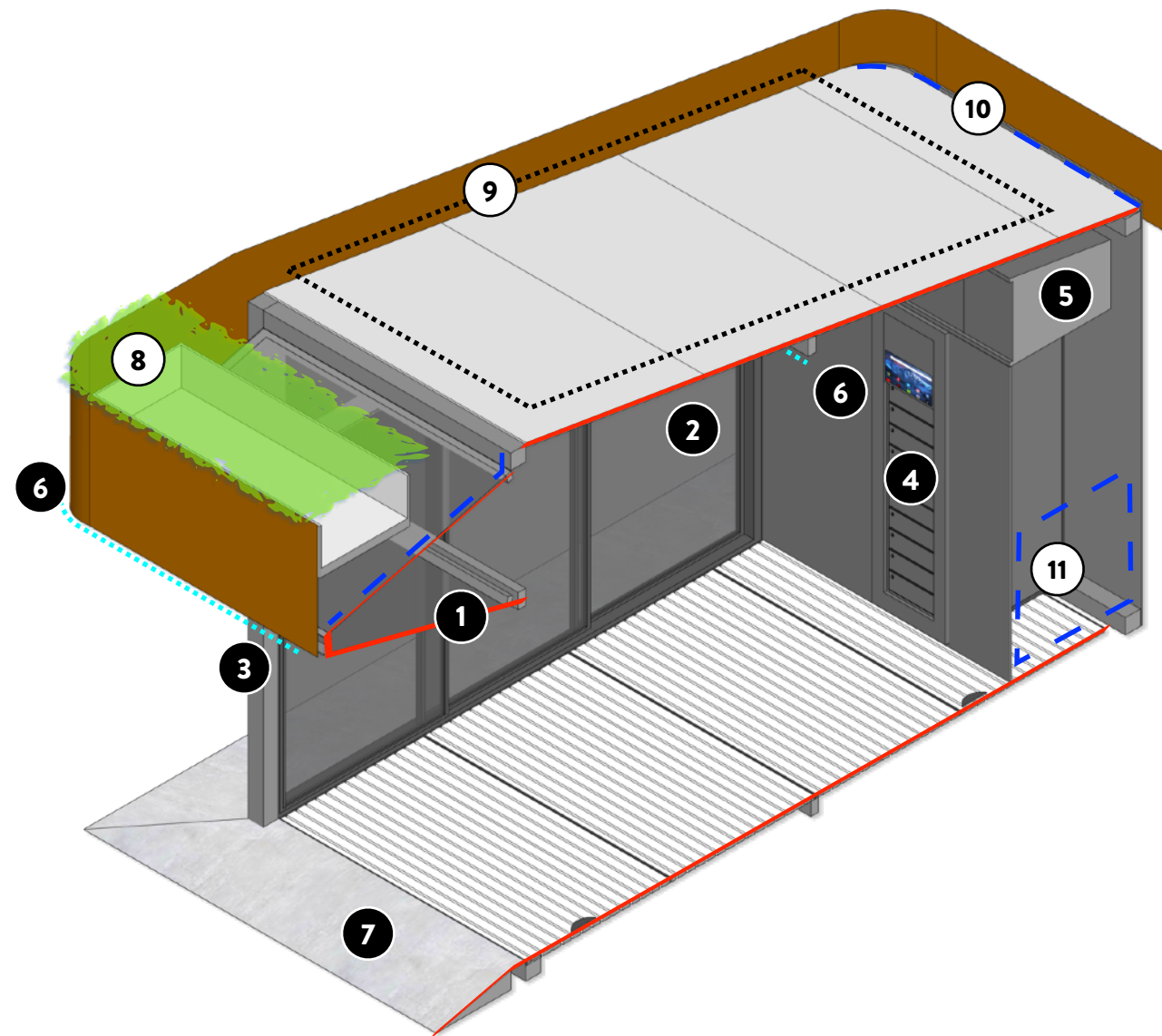

- 1 Automatic Tempered Glass Rollup Doors
- 2 Automatic Tempered Glass Sliding Doors
- 3 Access Control Panel
- 4 Oonee Power Charging Cabinets
- 5 HVAC System / Cooling + Heating
- 6 RGB LED Lights (Interior + Exterior)
- 7 Raised Leveling Platform + ADA Ramp

OPTIONAL SYSTEMS + FEATURES

- 8 Green Roof
- 9 Solar Panels
- 10 Rainwater Catchment System
- 11 Irrigation Tank

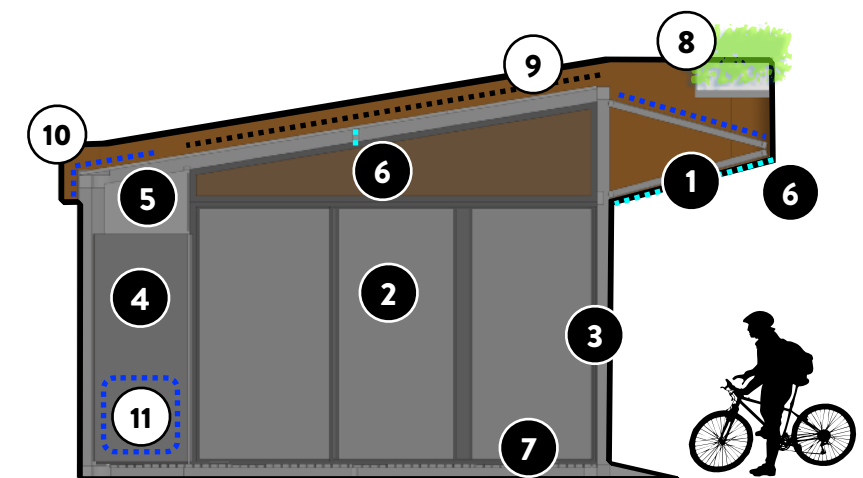

REST

RECHARGE

REPAIR

ABOUT FANTÁSTICA

- FIRST NYC DOT TEMPORARY PLAZA DESIGN - PEARL STREET TRIANGLE IN DUMBO BK
- CITY-WIDE STANDARD DESIGN FOR DOT'S STREET SEATS PROGRAM
- OUTDOOR DINING MODULAR SYSTEM DESIGN LAUNCHED AS PART OF TIMES SQUARE'S DESIGN LAB (TSQDL)
- FANTÁSTICA IS PROUD TO BE A MINORITY AND WOMAN-OWNED BUSINESS (M/WBE)



REST



RECHARGE



REPAIR

SIMILAR PAST PROJECTS



OONEE POD PORT AUTHORITY BUS TERMINAL



OONEE POD HOLLAND TUNNEL



OONEE POD JERSEY CITY

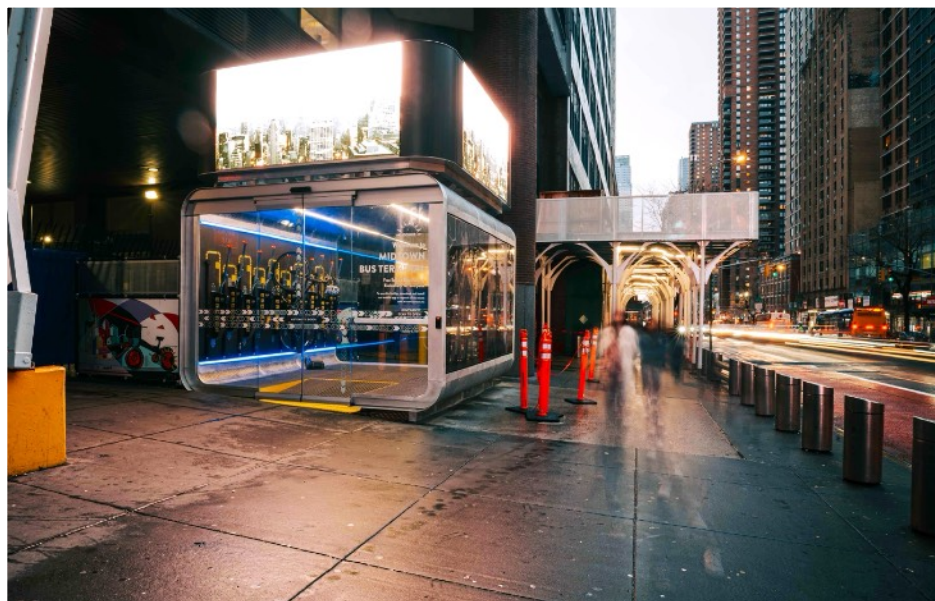

REST



RECHARGE



REPAIR